



US 20050246059A1

(19) **United States**

(12) **Patent Application Publication**

**Meyer**

(10) **Pub. No.: US 2005/0246059 A1**

(43) **Pub. Date: Nov. 3, 2005**

(54) **MLS-HYDROXYL FILLING STATION (MLS-HFS)**

(22) Filed: **Apr. 22, 2004**

(75) Inventor: **Stephen Foster Meyer, Golden Valley, MN (US)**

**Publication Classification**

(51) **Int. Cl.<sup>7</sup> ..... G06F 17/00**  
(52) **U.S. Cl. .... 700/231**

Correspondence Address:

**STEPHEN F. MEYER  
12 N. MEADOW LANE  
GOLDEN VALLEY, MN 55422 (US)**

(57) **ABSTRACT**

(73) Assignee: **Mr. Stephen Foster Meyer, Golden Valley, MN (US)**

The utility of the MLS-HFS hydroxyl filling station, its configuration, design, and operation is the keystone of a new type of automation the production of hydroxyl gases from renewable resources.

(21) Appl. No.: **10/709,215**

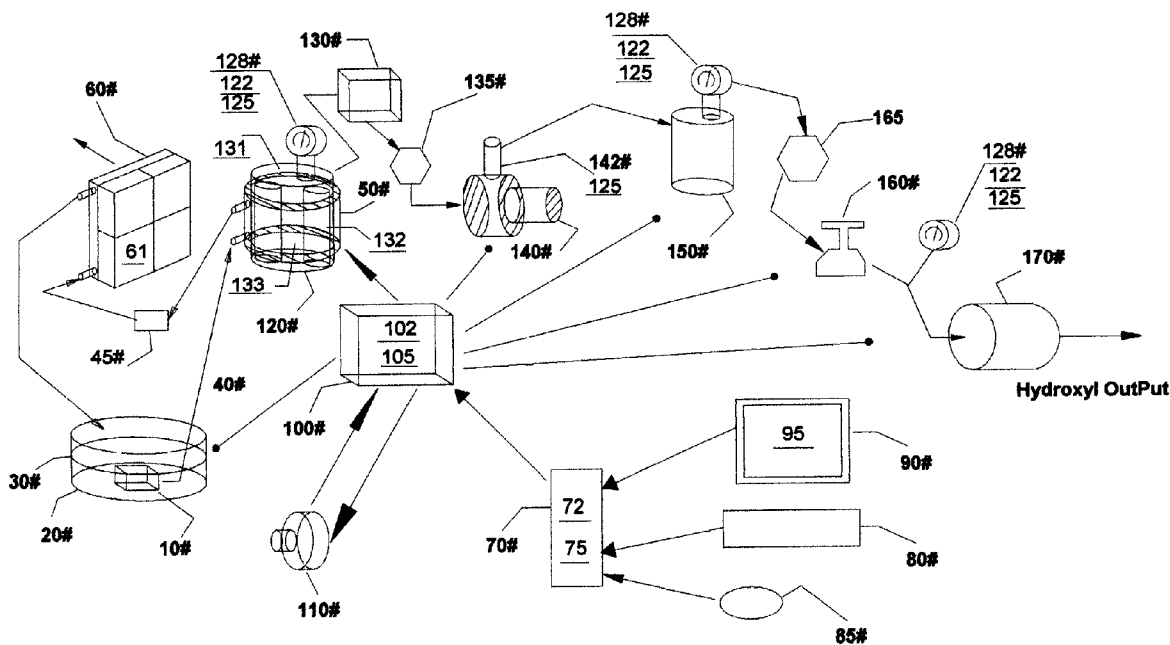

**MLS- Hydroxyl Filling Station (MLS-HFS)**

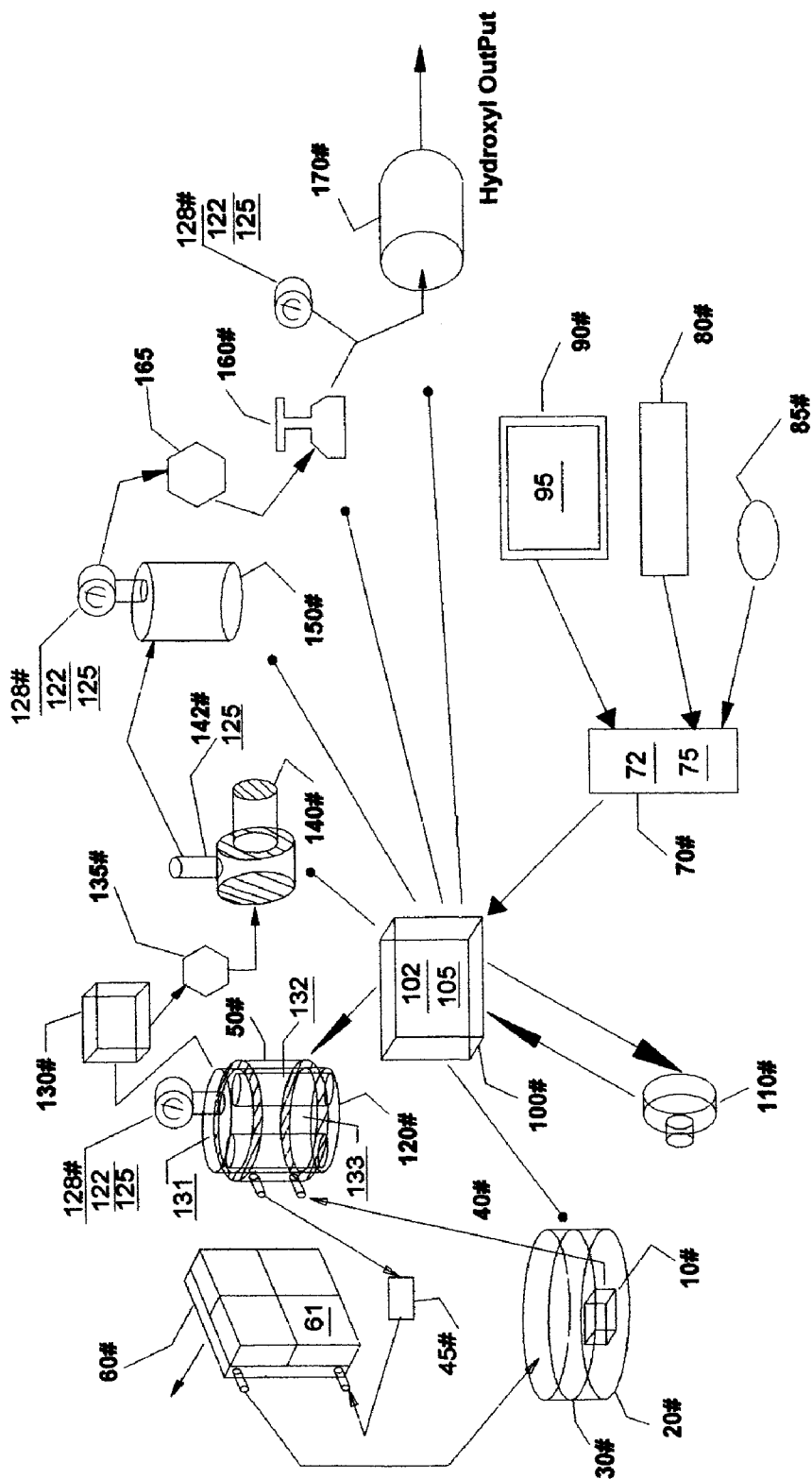

MLS-Hydroxyl Filling Station (MLS-HFS)

**Fig 1**

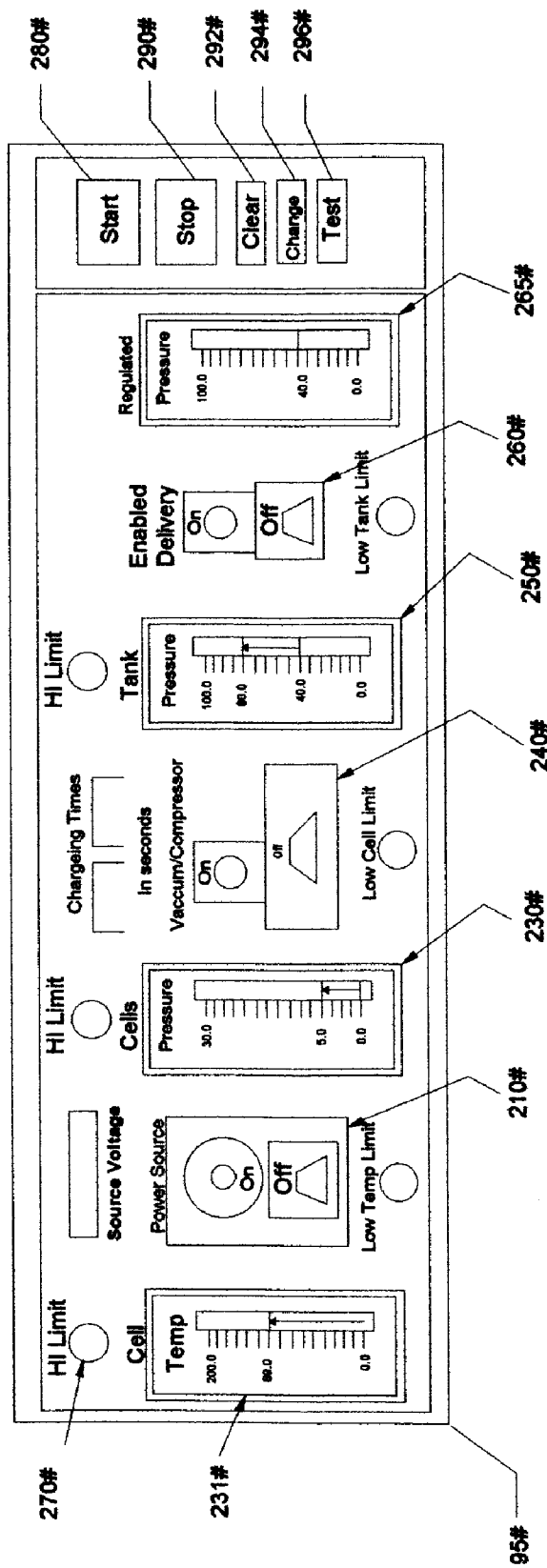

MLS-Hydroxyl Filling Station (MLS-HFS) Graph Display and Operator Control File: DisplayFig2.dcd

**Fig-2**

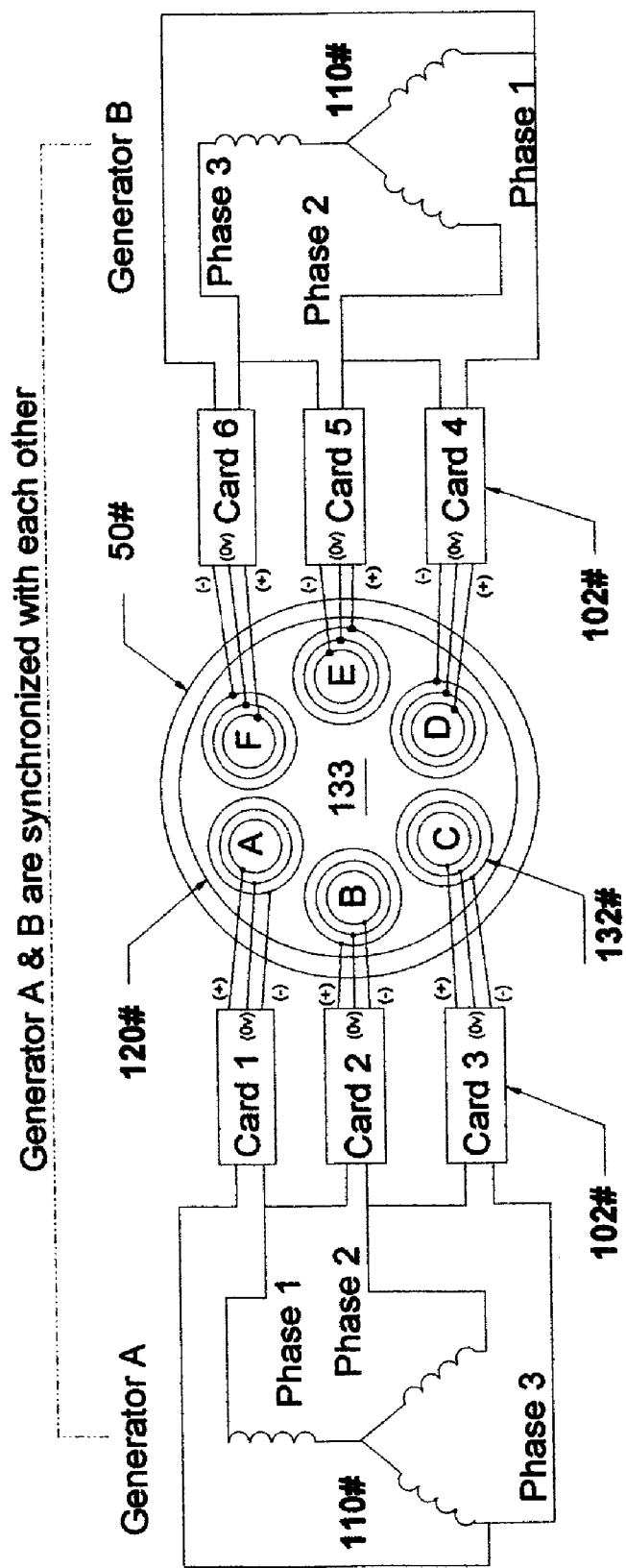

File: CellApparatusPatent.doc

Configuration of Hydroxyl gas producing apparatuses  
**Fig-3**

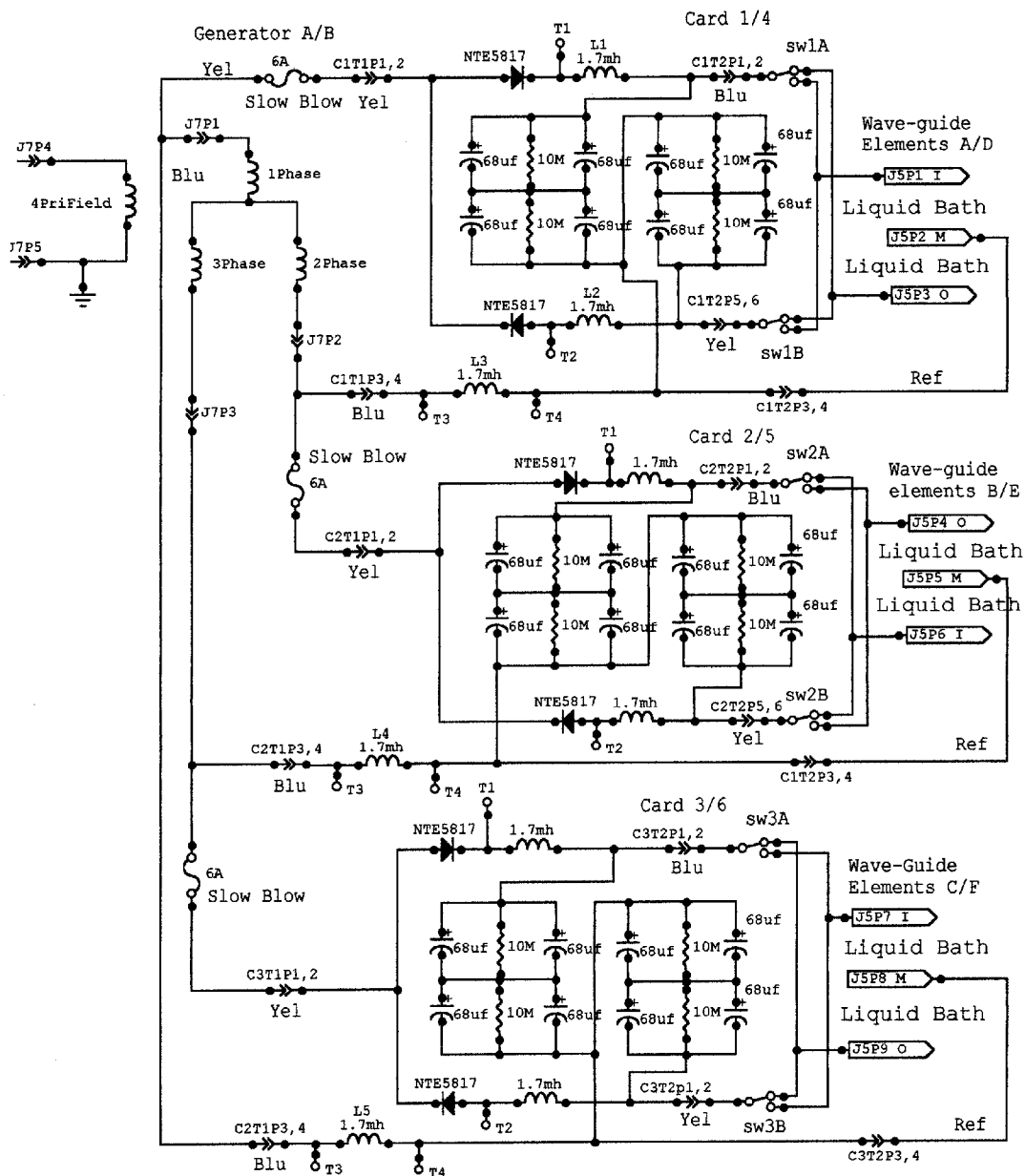

Impedance matching circuits 102

Fig-4

**Signals Traveling Wave Guide**

Xa: 2.988m Xb: 5.000m a-b:-2.012m freq: 496.9  
Yc: 15.49 Yd: 3.450 c-d: 12.04

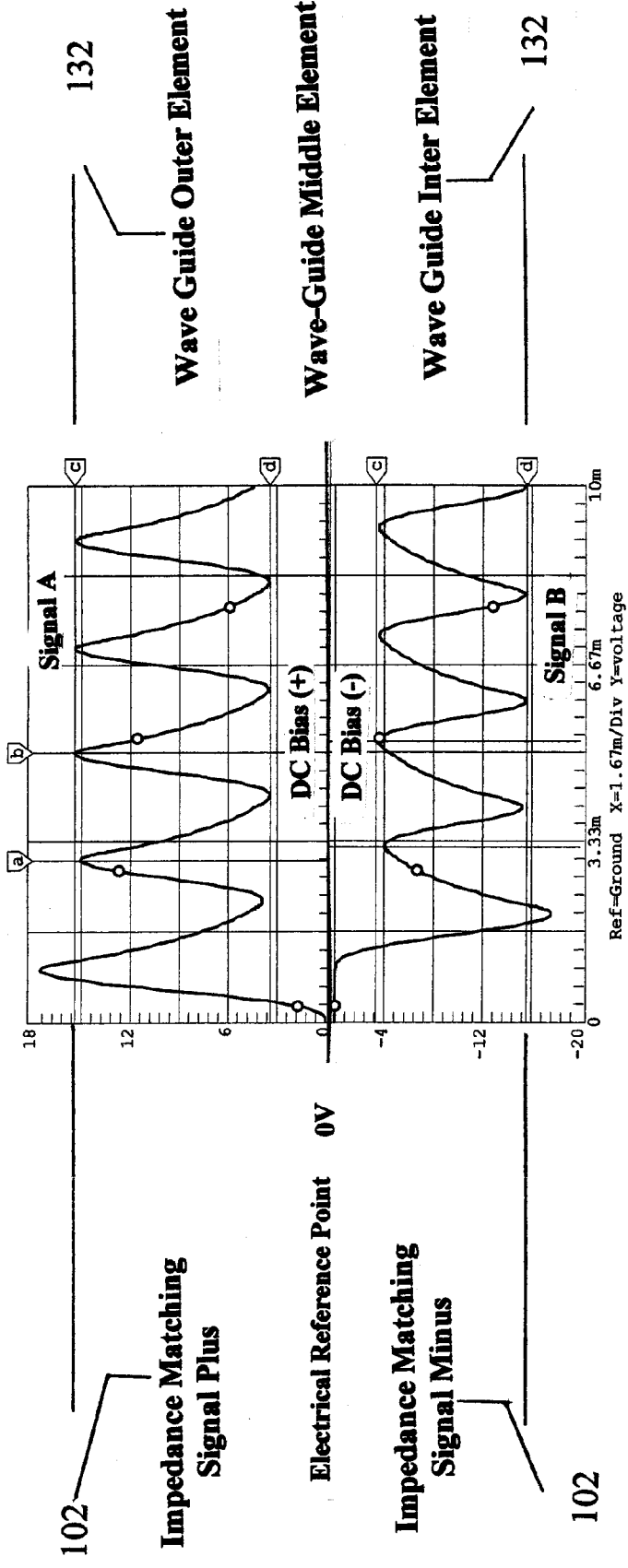

**FIG-5**

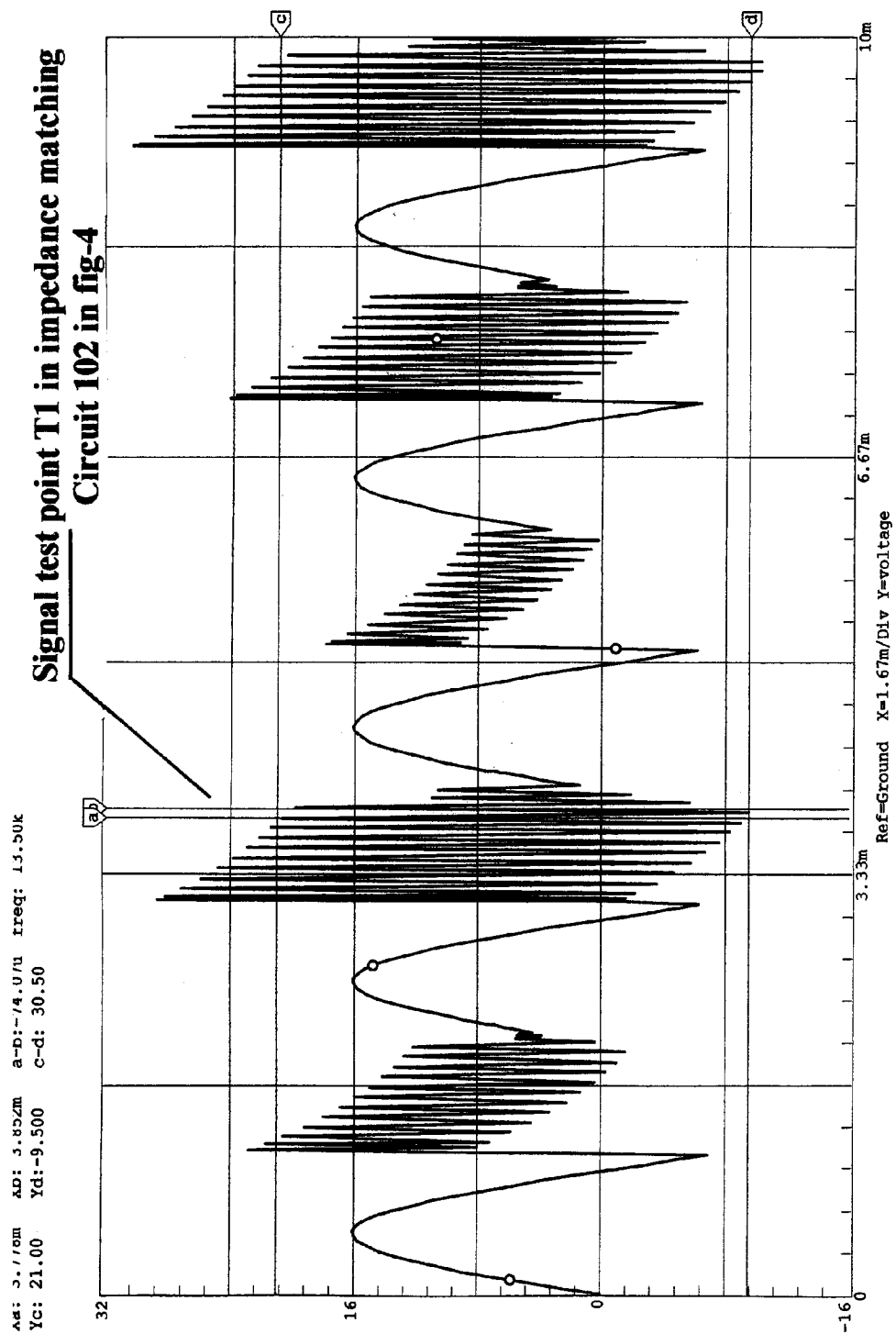

**FIG-6**

**MLS-HYDROXYL FILLING STATION (MLS-HFS)****COPYRIGHT STATEMENT**

[0001] copyright© 2001-2004 by Stephen F. Meyer, All right reserved.

**BACKGROUND OF INVENTION**

[0002] Fuel cell and auto industries have been looking for methods and apparatus that can supply a source of hydrogen and oxygen for its new hybrid industry. This invention is such a device

**SUMMARY OF INVENTION**

[0003] The invention is a computerizes automatic on site/mobile hydroxyl gas producing filling station that allows the products being produced to be used either by the hydrogen fuel cells installed in automobiles, trucks, buses, boats and land base generating applications or in any internal combustion engine.

**BRIEF DESCRIPTION OF DRAWINGS**

[0004] Drawing **FIG. 1** shows the configuration of apparatus used in the MLS-hydroxyl filling Station (MLS-HFS).

[0005] Drawing **FIG. 2** shows the software display the operator uses to monitor and control the production of hydroxyl gases and heat.

[0006] Drawing **FIG. 3** shows the methods, configuration, and apparatus used in the hydroxyl producing cell **120** system.

[0007] Drawing **FIG. 4** shows the electronic impedance matching circuits **102** connected between the dual three phase generators (A&B) **110****FIG. 3** and each of the wave-guide arrays **132** in cell **120****FIG. 3**. Note that only generator A is depicted in the drawing **FIG. 4** as being connected to arrays A-B-C using PC cards **1-3**. Generator B is connected to arrays D-E-F using cards **4-6**.

[0008] Drawing **FIG. 5** shows the signals applied to each of the arrays **132****FIG. 3** installed in hydroxyl cell **120** emitted from each of the impedance matching circuits **102****FIG. 4** mounted on PC cards **1-6**. These sets of signals **FIG. 5** with their offsetting phase relationship, frequencies and amplitudes are the driving forces producing the hydroxyl gases in cell **120****FIG. 3**.

[0009] Drawing **FIG. 6** shows the high frequency ringing signal located between test points T1 and T2 in impedance matching circuit **102** drawing **FIG. 4**. It is this ringing that also enhances the production of the hydroxyl gases in cell **120****FIG. 3**.

**DETAILED DESCRIPTION OF THE DRAWINGS**

[0010] **FIG. 1**

[0011] The heat removing section in **FIG. 1** consist of a liquid bath **30** and its container **20**, a liquid circulating pump **10**, conveying conduits **40**, cooling chamber **50** attached to hydroxyl generating cell **120**, filter **45**, radiator **60** and cooling fans **61** attached to it.

[0012] The automatic control section in **FIG. 1** consist of a computer **70** software program **75** video monitor **90** and its graphic operator display **95** (**FIG. 2**) pointer **85** keyboard **80**

interface card **72** and I/O controller **100** with its driver electronics cards **102** and **105**.

[0013] Dual three phase power sources **110** and impedance matching circuits **102** provide the power needed to drive the hydroxyl cell **120**.

[0014] The remaining apparatus are used to conduit the gases from cells **120**, through liquid trap **130**, through gas flow restriction valve **135**, elevate its gas pressures through compressor **140**, transfer them to storage tank **150**. Then deliver the gases through safety cut off **165** regulators **160** through flash back arrestor **170** for external delivery.

[0015] **FIG. 2**

[0016] **FIG. 2** shows the layout and functions of the operator control display **95** emulating from program **75****FIG. 1**. It consists of cell temperature indicator **231****FIG. 2** cell power activator **210** cell pressure indicator **230** vacuum controller **240** hi-pressure tank indicator **250** delivery controller **260** delivery regulated pressure indicator **265** and related alarm/status indicators **270**. Also software control buttons are provided to start **280** stop **290** clear data **292** change setting **294** and testing of equipment and their sequences **296**.

[0017] **FIG. 3**

[0018] **FIG. 3** shows the configuration of our proprietary hydroxyl producing apparatus **120** consisting of dual three phase power source **110** impedance matching electronic circuits **102** and gas converters devices **132** submersed in a bath of water **133** in cell **120**. The drawing also shows the water jacket **50** surrounding the cell **120** that helps lower its temperature and allows more production of the hydroxyl gases at higher voltage signals **FIG. 5**.

[0019] **FIG. 4**

[0020] **FIG. 4** shows the electrical circuits **102** used to drive the gas converting arrays **132****FIG. 3** submersed in a bath of water **133** in cell **120**. The drawing **FIG. 4** depicts three identical circuits connected to each of the three phase signals from  $\frac{1}{2}$  of the dual three phase generator A **110** **FIG. 3**. The circuits **102****FIG. 4** convert the AC signal from each phase of **110** into a modulated signal as depicted by **FIG. 5**. These signals are then coupled to the triple array **132** elements (Inside, Middle, outside) by alternating the connection between the inside and outside elements of the arrays **132****FIG. 3**.

[0021] **FIG. 5**

[0022] **FIG. 5** Shows the composite signals applied to each of arrays **132****FIG. 3** submerges in water bath **133** in cell **120** and indicates the differential voltages used in the hydroxyl producing process MLS-HFS. Note that the center wave-guide element is used as the electrical reference point for both outside and inside elements of array **132**. It is this composite signal applied to the surface of the stainless steel elements in array **132** submerge in water bath **133** that allow the ions from the elements in array **132** to cross its water **133** surface barriers and contribute to the hydroxyl production. Note the dc bias voltage +,- on either side of the center electrical reference point OV in **FIG. 5**. It is this bias voltage being modulated by multi polarity differential signals from **102****FIG. 4** that contributes to the wave-guide action of arrays **132**. Also, the frequency of **FIG. 5** is adjusted to



match the electrical wave-length of the arrays **132** **FIG. 3** and the impedance of water bath **133**.

**[0023] FIG. 6**

**[0024] FIG. 6** shows the high-frequency ringing signals that contribute to the operation of the hydroxyl production. Just as a tuning fork rings when struck by a hammer, so does the wave-guide elements in arrays **132** immersed into the hydroxyl generating liquid **133** then struck by the electrical signals **FIG. 5,6** from impedance matching circuits **102** depicted in **FIG. 4**.

**[0025] Brief Description of Sequences**

**[0026]** This invention is a computerized Hydroxyl gas producing filling station MLS-HFS designed to provide automatic control of its on site gas production and delivery.

**[0027]** The MLS-HFS **FIG. 1** is a hydroxyl gas and heat generating system using a renewable source of liquid supply **30** such as water. It uses a computer control program **75** with display interface **95** for the monitoring, adjusting and controlling of the electronic and hardware apparatus and process logic. The electronic circuits **102** mounted in driver **100** controls the production of the gases and heating while circuit **105** control the process and routing of the hydroxyl gas.

**[0028]** The MLS-HFS consists of a low-pressure hydrolyser cell **120** **FIG. 1**, a liquid trap **130**, an adjustable flow restriction value **135**, high-pressure vacuum compressor **140**, and check valve **142** installed in **140**. It also contains a high-pressure storage tank **150**-alarm/low pressure cut off valve **165** gas regulator **160** flashback arrestor **170** and over pressure safety release valves **125** pressure gauges **128** and analog pressure sending units **122** installed on cell **120**, tank **150** at the regulating side of regulator **160**. Also **125** is installed on Compressor **140** high pressure out-put. The computer controller **70** monitor **90** keyboard **80** interface I/O card **72** and software position pointer **85** is used to control the production process using electronic driver **100** through its PC boards **105** and their attached control devices. The power to the cell driving circuits **102** installed in driver **100** is supplied from a dual three phase isolated power source **110**. The amplitude, signal phases, and frequency from this power source is controlled by signal adjustments from the computer **70**.

**[0029] Detailed Description**

**[0030] Sequence of Operation**

**[0031]** The MLS-HFS **FIG. 1** is monitored and controlled by the soft-ware program **75**-computer **70** monitors **90** keyboard **80** pointer **85** and display interface **95**, **FIG. 2**.

**[0032]** The software program **75** **FIG.1** has five main functions.

**[0033]** They are: to purge the system of ambient air, check and test for any equipment malfunctions, ready the system for production, monitor and control current activities of the production and safety shutdown of the system on detection of alarms.

**[0034]** During the initial installation and after any repairs the total system is purge via the vacuum pump **140** by manual rerouting valuing to ensure that all-ambient air has been removed from the system.

**[0035]** Before the system is put into service the operator via the graphic display **95**, **FIG. 2**, keyboard **80** monitors **90** and pointer **85** can test the system for operation. The main functions of the testing is to ensure that the temperature electronics **131** attached to the hydroxyl cells **120** transferring compressor **140** and analog pressure sensors **122** mounted on cells **120** high pressure tank **150** and discharge side of regulator **160** used for control and monitoring are working properly. The operator then can activate the run sequence of the program **75** via start software button **280** **FIG. 2** on graphic display **95**.

**[0036]** During the initial startup phase of the MLS-HFS system **FIG. 1** the computer program **75** will configure the system for the purge sequence. This sequence will allow the vacuum pump **140** to draw down the hydroxyl cells **120** liquid trap **130** coupled to flow restriction value **135** and compressor **140** to removing all ambient air from them. Once the program **75** has detected no leaks, it then readies the system for gas production by routing the gas flow from **120** to high-pressure tank **150** and then to output flash back protector **170**.

**[0037]** The program **75** starts off its production sequence by first turning on the cooling system consisting of liquid pump **10** that is submerge in liquid bath **30** contain in vessel **20**. The cooling liquid **30** is pumped through cooling jacket **50** attached to the outside of cells **120** through Filter **45** and then through cooling air radiator **60**. Fans attached to the radiator **60** are turned on for cooling.

**[0038]** Next the computer **70** turns on the dual three phase power source **110** that supplies the frequency, phase shifting and signals amplitudes to impedance matching circuits **102** **FIG. 4** which is coupled to hydroxyl producing cells **120**.

**[0039]** The result of this is just like the operation of a radio transmitter matching its signal to the air via the antenna impedance. Refer to **FIG. 3** showing the relationship of this configuration to arrays **132**, water bath **133** and Signals **FIG. 5,6**.

**[0040]** While the power source **110** is operating, computer **70** is monitoring the pressure **122** and temperature **131** of hydroxyl cell **120**. When the cell pressures reaches a typical level of 5 pounds, the power source **110** is turned off and the compressor **140** is turned on starting the conveying of hydroxyl gases to high-pressure tank **150**. When the hydroxyl cells **120** is drawn down to near zero pressure, the compressor **140** is turned off and power source **110** is turned back on starting the production cycle again.

**[0041]** The production cycle is repeated until tank **150** reaches a typical level of 80 pounds. At this time the computer **70** enables the output pressure regulator **160** set at a typical level of 40 pounds for the delivery of the hydroxyl gas to some external storage system or device.

**[0042]** During the production of hydroxyl gases computer **70** cycle the apparatus to maintain required levels. At the same time, the graphic display **95** indicates the activities of the system and alerts the operator of any malfunctions or process warnings.

**[0043] Impedance Matching Circuit 102**

**[0044]** The impedance matching circuits **102** **FIG. 4** converts the sine-wave signals from the three phase power

source **110** **FIG. 3** into multi polarity differential signals **FIG. 5** that are applied to the triple wave-guide clusters arrays **132 A,B,C,D,E,F** installed in cell **120**.

[0045] Its is this converted signal **FIG. 5** along with the phase relationship of the power source **110** and the triple wave-guides element in cluster **132** that are submerge in a water bath **133** that produces the hydroxyl gases. It is important to note that not only is the gas produced between the elements in an array but also, between each array installed in cell **120** **FIG. 3** (see array A-B-C phase relationship). Also that the array elements themselves are supplying much of the ions needed for the production of the gases.

[0046] Sequence of Hydroxyl Gas Generation

[0047] Once the hydroxyl-generating cell **120** has been purged of Ambient air and production routing completed (**FIG. 1**). The dual three-phase power source **110** is activated supplying frequency, amplitude, and phase signals to impedance matching circuitry **102**. The converted signals from **102** are then applied to cell array **132** for processing. It is the combination of the impedance matching circuits **102**-signal transformations **FIG. 5,6**; the cell configuration and materials used in arrays **132** and the rotational phase relationship between arrays AD, BE and CF and the submersion of these arrays **132** in a bath of water **133** that allows the MLS-HFS to produce large amounts hydroxyl gases. The computer program **75** and its graphic display **95** is used by the operator to adjust the rate of gas production and set the upper limit that the low pressure cell **120** will charge to.

[0048] After the cell **120** has reached its upper pressure cutoff limit (typically 5LBS). The power source **110** is turned off enabling the compressor **140** to start its draw down and transferring of the gases to the high-pressure tank **150**. When the pressure in the cell **120** reaches a low-level limit (near zero LBS) **140** stops its charging cycle of **150**. Check value **142** installed in **140** prevents any back flow of gases to **120** from the high-pressure tank **150**. The power source **110** is then turned back on repeating the cycle. The charging cycles continual until high-pressure tank **150** reaches its upper pressure limit (typically 80 LBS) stopping the production of hydroxyl. As the gases are being used and/or transferred to external containers. The pressure is monitored for low-level cut-out limit (typicality 40 pounds) at pressure regulator **160** output . Once at this level the gas production cycle is restarted.

[0049] During cell **120** operations, the temperature is monitored for out of limit conditions set by control **231** using

the graphic display **95**. Should the temperature reach an excess limit, the gas production is stopped and the computer program **75** alerts the operator of the problem. The cooling system **30** using water jacket **50** attached to cell **120** helps reduces the temperature **131** and allows for higher gas production.

[0050] After extended running times, the water in cell **120** is replenished by bath **30** and filtered by **45** to help control the operating impedance of the cell.

[0051] A listing related to software program **75** is depicted in text files attached to ePAVE and their file names are as follows: CombustAllP1 through CombustAllP19, Tank-TrackingDataFormP1-P2, TempTrackingFormP1-P2 and CellChargeTimeP1-P2.

1. The MLS-HFS information in this specification is the embodiment of the claims.
2. The system according to claim 1 further enhances the production of Hydroxyls based on the configuration of the Hydroxyl gas producing apparatuses **FIG. 3**.
3. The system according to claim 1 further enhances the production of hydroxyls based on the configuration of the impedance matching circuits **FIG. 4**.
4. The system according to claim 1 further enhances the production of hydroxyls based on the application of the electrical signals **FIG. 5** applied to signal traveling wave-guides **132** submersed in a bath of water **133** installed in cell **120** and configured as depicted in **FIG. 3**.
5. The system according to claim 1 further enhances the production of hydroxyls based on the resonating action of electrical signals depicted in **FIG. 6**.
6. The system according to claim 1 further enhances the production of hydroxyls based on the software program **75** ability to control the production of hydroxyl gases; controlling its process limits, controlling its storage and controlling its delivery via operator controller **FIG. 2**.
7. The software program **75** according to claim 6 further enhances the safety of the production of hydroxyls based on the monitoring of high and low limits and either alerting the operator of the condition/s and/or stopping the production on device failures via operator controller **FIG. 2**.
8. The software according to claim 6 further enhances the safety of the production of hydroxyls based on its ability to purge the system of ambient air before starting the production of hydroxyl gases.

\* \* \* \* \*